

NOTE 1)

No.	PART NAME	MATERIAL	Qt'y	SIZE	REMARK
01					

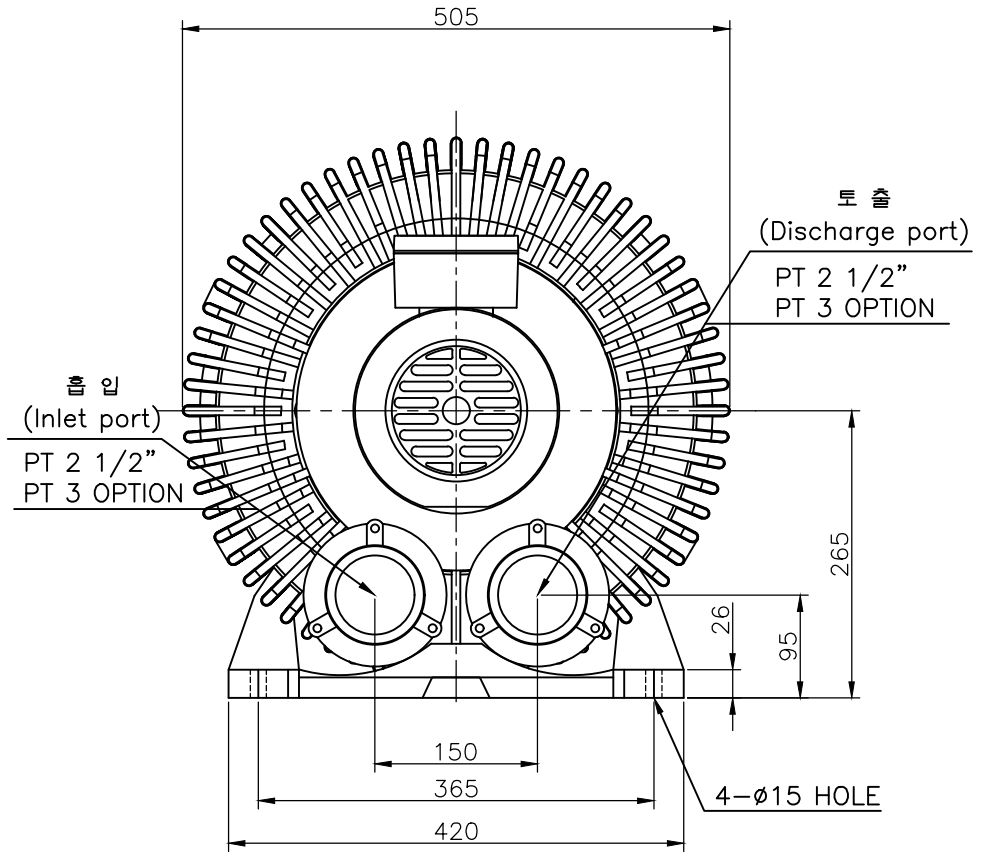
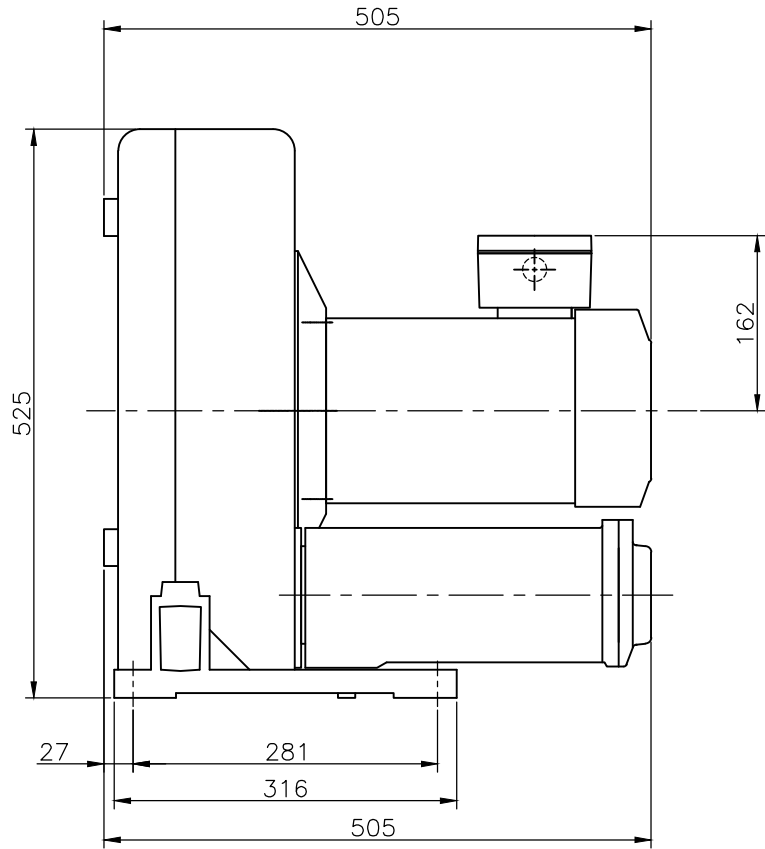

△		Revision		00	Date	Draw	Check	Appr.
No.	HRB-750 MP			도명	OUTWARD DWG.			
형식	TYPE			도명	TITLE			
DRAWN	DESIGN	CHECKED	APPROVED	3RD ANGLE	SCALE:1/1	UNIT:mm		
B.S.Kim				SIZE	3Ø 2P 4.5Kw			
10.11.18				도번	BOD00169		△	
黃海電機 HWANG HAE ELECTRIC				도번	BOD00169		△	
				DWG. No.	BOD00169			